

# KLORIS®

the new way we live



## *KLORIS DESIGN / LIGHTING*

Easybar .....	3
Openbar .....	5
Sistema di montaggio / Hookup .....	6
Accessories .....	7



COD.	Mod.	a mm	b mm	c mm	d mm
KOPB090	150	1480	725	1100	420

■ Accessori venduti separatamente  
■ Accessories not included

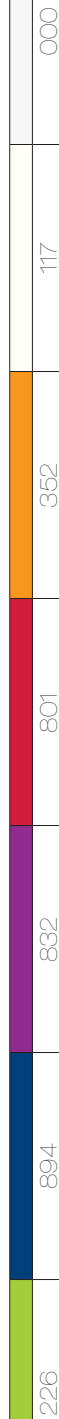
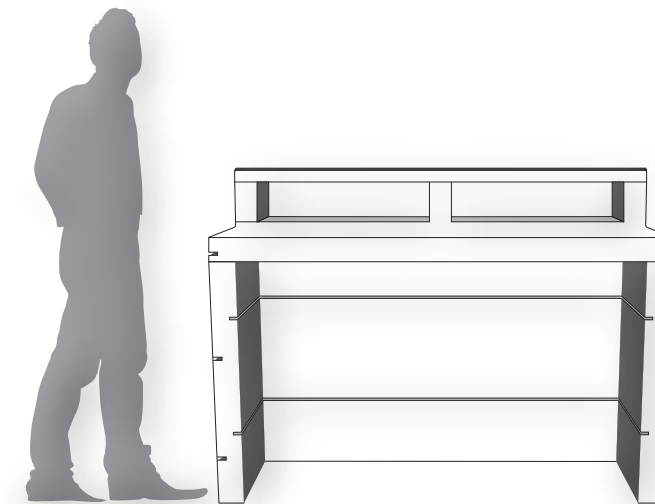
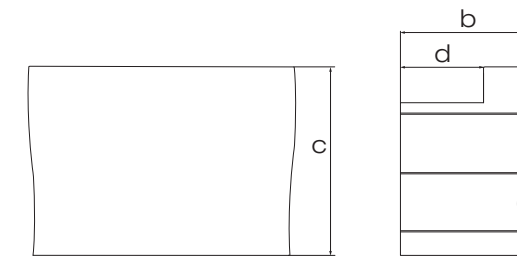
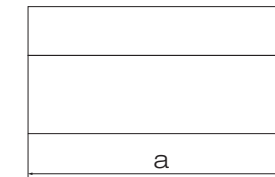

# OPENBAR

bancone / counter  
designer Kloris Studio





COD.	Mod.	a mm	b mm	c mm	d mm
KEYB150	150	1420	820	1100	710

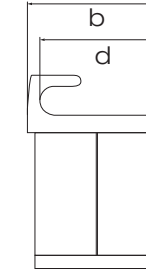
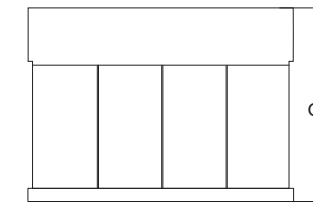
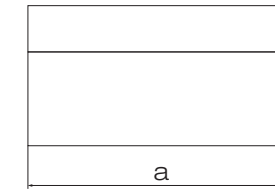

# EASYBAR

bancone smontabile / decomposable counter  
*designer Kloris Studio*



# SISTEMA di MONTAGGIO

Hookup

**SISTEMA  
BREVETTATO**

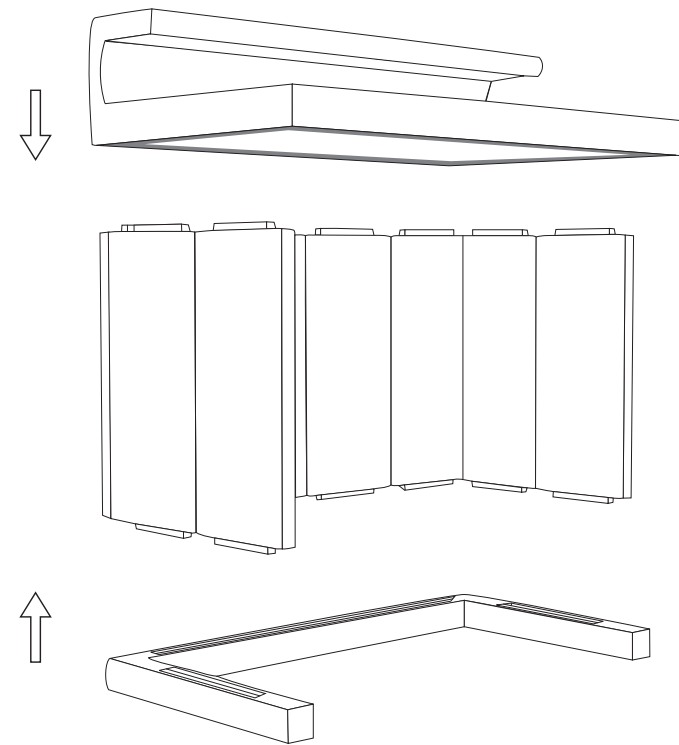

- comodo da trasportare / *easy to carry*
- facile da montare / *easy to assemble*
- semplice da usare / *easy to use*

Sistema di montaggio / Hookup

ADATTABILITÀ / SUITABLE

Easybar

- Confezione composta da: n. 1 piano lavoro con alzatina • n. 8 pannelli da incastro • n. 1 base d'appoggio
- Package contains: n. 1 worktop with shelf • 8 Assemble panels • 1 Base

Multiple

COD.

ADATTABILITÀ / SUITABLE

KCIL006

Openbar - Clipper

- 3 lampade a tubo E27 20W incluse
- 3 Tube lamps E27 20W included

Stripe LED

COD.

ADATTABILITÀ / SUITABLE

KCIL013

Easybar

- Striscia da 336 LED IP 67 • 27 W • alimentatore IP 40
- 336 LED IP 67, 27W, IP40 charger

Workstation

COD.

ADATTABILITÀ / SUITABLE

ACWK140

Easybar - Openbar - Clipper

- Piastra in acciaio completa di vaschette, lavabo e rubinetto. Dimensioni e quantità delle vaschette variabili in base al modello del bancone
- Steel workstation with bowls, washbasin and tap. Size and quantity of bowls depend on the counter model

Piani in plexiglass

COD.

ADATTABILITÀ / SUITABLE

ACPL140

Easybar - Openbar - Clipper

- Spessore 5 mm
- Gauge 5 mm

n. 2 mensole in vetro

COD.

ADATTABILITÀ / SUITABLE

ACVE140

Openbar

- Spessore 6 mm
- Gauge 6 mm

# LIGHTING KIT



Multiple



Stripe LED

# WORKSTATION





**GIURGOLA** s.r.l.

Via Pavia, 36 - C.P. 74 - S.P. 362 km 14,500 (Z.I.)  
73013 GALATINA (Lecce) - ITALY  
tel.: +39 0836 562826 - fax: +39 0836 568181  
e-mail: [info@kloris.com](mailto:info@kloris.com) - website: [www.kloris.com](http://www.kloris.com)



MADE IN ITALY